

Content:	EAN	W	Max lm	K	P _a	t _a (°C)	V _{ac}	Hz	kg
	8719157051774	28	3360	3000/4000/6500	>80	-10...+35	220-240	50/60Hz	1.60
	8719157051781	28	3360	3000/4000/6500	>80	-10...+35	220-240	50/60Hz	1.60
	8719157051798	28	3360	3000/4000/6500	>80	-10...+35	220-240	50/60Hz	1.75
	8719157051804	28	3360	3000/4000/6500	>80	-10...+35	220-240	50/60Hz	1.75
	8719157051811	28	3360	3000/4000/6500	>80	-10...+35	220-240	50/60Hz	1.60
	8719157051828	28	3360	3000/4000/6500	>80	-10...+35	220-240	50/60Hz	1.60
	8719157051835	13	1560	3000/4000/6500	>80	-10...+35	220-240	50/60Hz	0.50
	8719157051842	20	2400	3000/4000/6500	>80	-10...+35	220-240	50/60Hz	0.90
	8719157051859	64	7680	3000/4000/6500	>80	-10...+35	220-240	50/60Hz	3.70

Inrush current	13W	20W	28W	64W	Remarks	Circuit Breaker				
Driver	PHILIPS	PHILIPS	PHILIPS	PHILIPS		Item	13W	20W	28W	64W
Inrush current I _{peak} (A)	9.91	20	16	31.2	Input voltage 230V	B16	98PCS	30PCS	36PCS	17PCS
Inrush current T _{width} (µs)	128	70	200	208	Input voltage 230 V, measured at 50% I _{peak}	C16	160PCS	50PCS	61PCS	28PCS

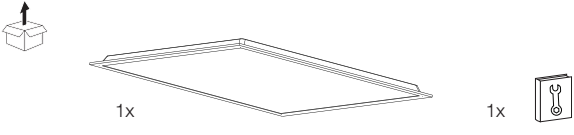

Color Switch

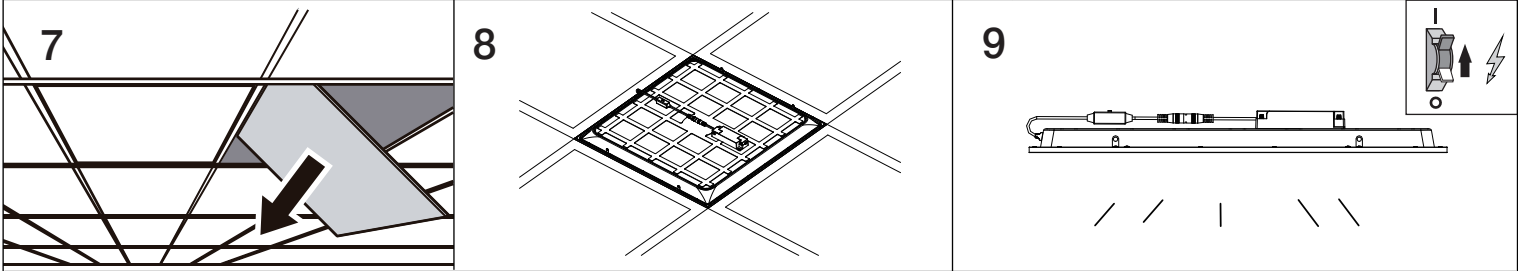
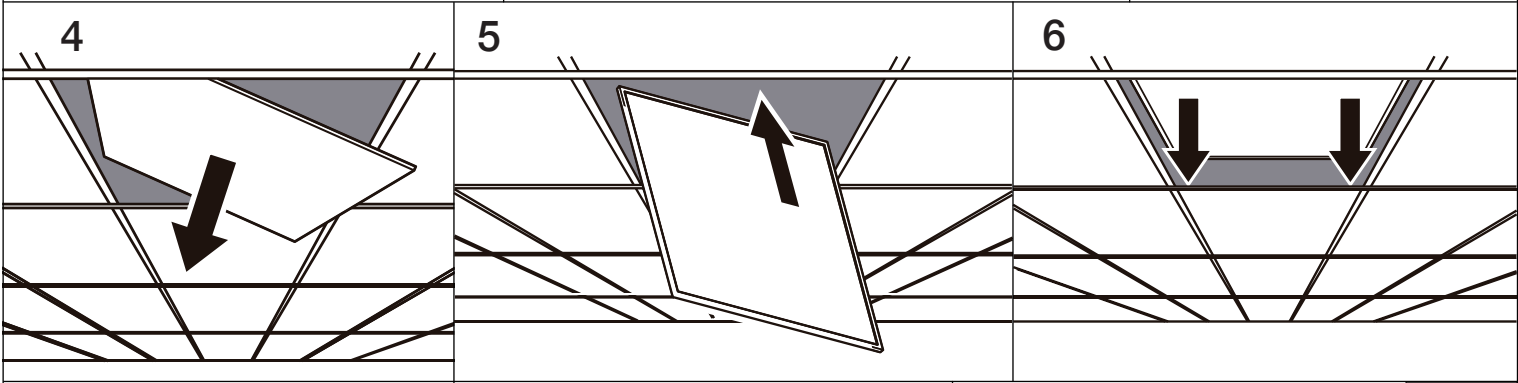
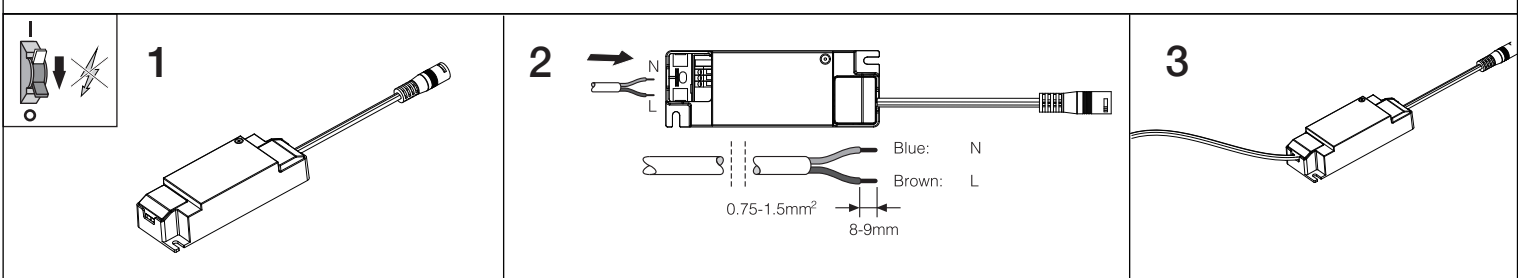
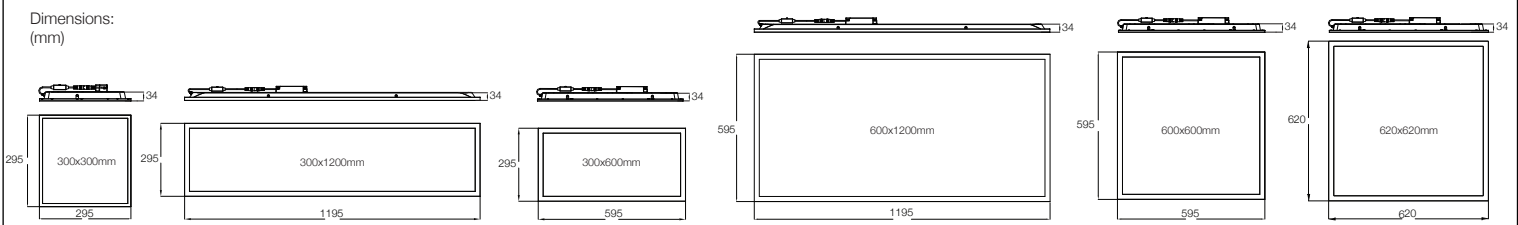
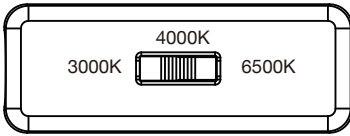

Please cut off the power before adjusting the Color Switch.

Factory setting: 4000K

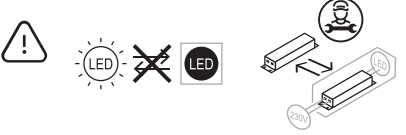

This product is equipped with a LED light source which cannot be replaced. This product have a control gear that can be replaced but only by authorised professional personnel.

Clean only with a soft cloth

Accessories (must be ordered separately)

Please be aware that the backplane might be slightly different for each item.

<p>Removable Surface Mounted Kit</p>	<p>Suspension Kit</p>	<p>Mounting Clips</p>	<p>Security cable 1.5m</p>
---	------------------------------	------------------------------	-----------------------------------

Removable Surface Mounted Kit 300x300,300x1200,300x600,600x600,620x620,600x1200mm

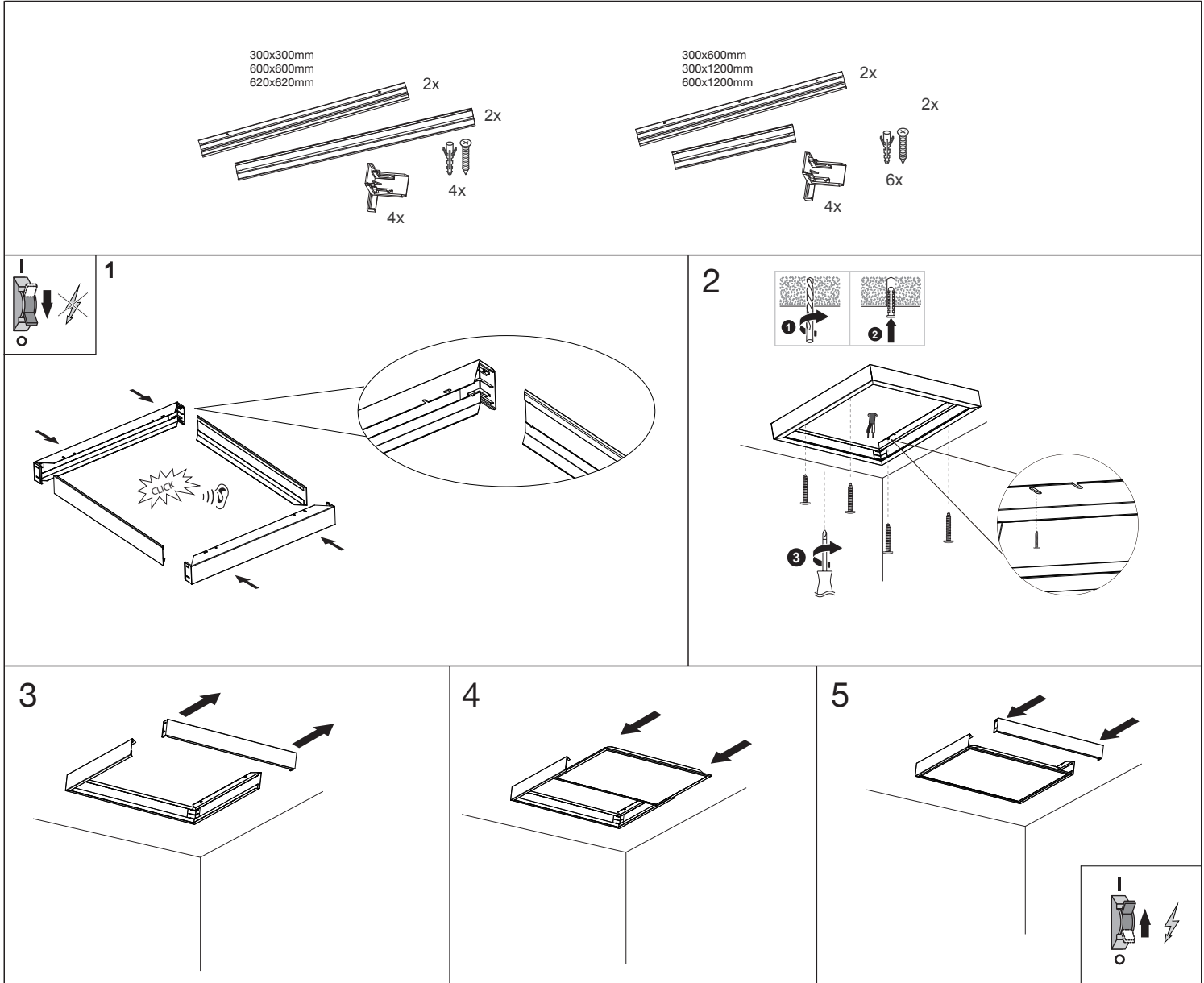

EN The luminaire shall be installed and maintained by a qualified electrician, in accordance with the national regulations in each country. The luminaire contains no replaceable parts. In case of the luminaire is damaged, it shall be exclusively replaced by the manufacturer or authorized dealer. Keep the operating manual for later use. The manufacturer is not responsible for the incorrect use and assembly of this product.

NL De armatuur dient te worden geïnstalleerd en onderhouden door een erkend installateur, in overeenstemming met de nationale regelgeving in het betreffende land. De armatuur bevat geen vervangbare onderdelen. Indien de armatuur is beschadigd dient deze enkel te worden vervangen door de fabrikant of door een erkende dealer. Bewaar de handleiding voor later gebruik. De fabrikant is niet verantwoordelijk voor onjuist gebruik en/of installatie van dit product.

DE Die Leuchte muss von einem qualifizierten Elektriker gemäß den nationalen Vorschriften in jedem Land installiert und gewartet werden. Die Leuchte enthält keine austauschbaren Teile. Falls die Leuchte beschädigt ist, wird sie ausschließlich durch den Hersteller oder den autorisierten Händler ersetzt. Bewahren Sie die Bedienungsanleitung für spätere Verwendung auf. Der Hersteller ist nicht verantwortlich für die unsachgemäße Verwendung und Montage dieses Produktes.

FR Le luminaire doit être installé et entretenu par un électricien qualifié, conformément à la réglementation nationale de chaque pays. Le luminaire ne contient pas de pièces remplaçables. Dans le cas où le luminaire est endommagé, il doit être remplacé exclusivement par le fabricant ou le revendeur agréé. Conservez le mode d'emploi pour une utilisation ultérieure. Le fabricant n'est pas responsable de l'utilisation et du montage incorrects de ce produit.

IT L'apparecchio deve essere installato e mantenuto da un elettricista qualificato seguendo le normative nazionali di riferimento. L'apparecchio non contiene parti sostituibili. In caso di rottura sarà sostituito esclusivamente dal produttore o da un rivenditore autorizzato. Conservate il manuale di installazione per eventuali utilizzi successivi. Il produttore non è responsabile per l'utilizzo ed il montaggio non corretto di tale apparecchio.

ES La luminaria debe de ser instalada y mantenida por un electricista cualificado, siguiendo las regulaciones nacionales de cada país. La luminaria contiene partes no reemplazables. En el caso de que la luminaria sea dañada, deberá ser reemplazada exclusivamente por el fabricante o distribuidor autorizado. Guarde el manual para usos posteriores. El fabricante no es responsable por el uso e instalación incorrecta de este producto.

NOXION

© 2024 Noxion B.V. - All rights reserved. Data subject to change without notice. Noxion retains the right to modify product specifications without any prior notice or obligation and does not assume any liability for any consequences of using this document. Subject to errors and printing errors.

Version: August 2024

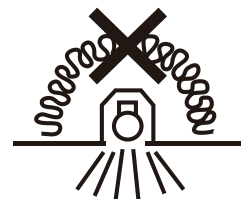

Noxion B.V.
 Schootense Dreef 27,
 5708 HZ Helmond
 The Netherlands
 +31(0)85-303 29 82
 www.noxion.com
 info@noxion.com

Page 2 of 3

Accessories (must be ordered separately)

Please be aware that the backplane might be slightly different for each item.

Suspension Kit

1 ceiling Ca. L mm

Panel size (mm)	Ca. L (mm)
300x300	173
300x600	315
300x1200	484
600x600/620x620	288
600x1200	471.5

35mm
 $\phi 6\text{mm}$

2 ceiling

3 ceiling

4

5 $\text{Ca. } 100 \text{ mm} - 1450 \text{ mm}$

2x
4x
8x ST 3.2
6x $\phi 6$
6x ST4

Mounting Clips

1

4x
8x ST 3.5

ceiling
 Ca. A mm
 Ca. B mm

Panel size(mm)	A X B
300x300	280 X 280
300x600	280 X 580
600x600/620x620	580 X 580
300x1200	280 X 1180
600x1200	580 X 1180

$>75\text{mm}$
 $>75\text{mm}$
10-20mm

Security cable 1.5m

1

1x
1x
2x ST 3.2

EN Install the hook (not provided) on a sound surface and perfectly anchored to carry the weight. **NL** Installeer de haak (niet meegeleverd) in een solide ondergrond en perfect verankerd om het gewicht te dragen. **DE** Installiert den Haken (nicht mitgeliefert) auf einer soliden Oberfläche verankert und perfekt, um das Gewicht zu tragen. **FR** Installé le crochet (non fourni) sur une surface solide et parfaitement ancrée à supporter le poids. **ES** Instale el gancho (no incluido) en una superficie sólida y perfectamente anclado para soportar el peso.

